

THIS DOCUMENT IS SUBJECT TO CHANGE WITHOUT NOTICE. IT IS CONFIDENTIAL AND A PROPERTY OF Amphenol LTW. DISCLOSURE TO THIRD PARTY HAS TO BE AUTHORIZED BY Amphenol LTW.

REV.	ECN NO.	DATE	SIGN	DESCRIPTION
B	LEN16A0097-099	2016/10/14	Yulong_wang	Add 3, 5Pin, IP69K & Cat5e Cable.
C	C201595	2020/10/16	Ruru	$\triangle C$ X6
D	C210211	2021/03/19	Ruru	$\triangle D$ X3

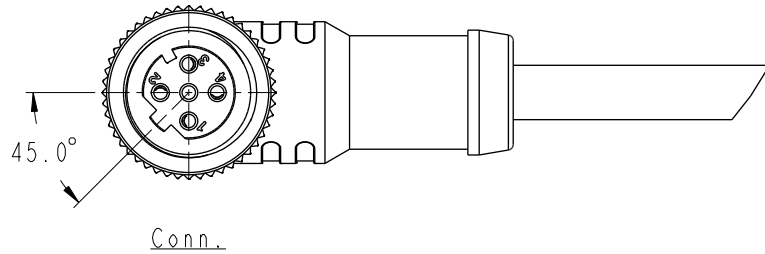
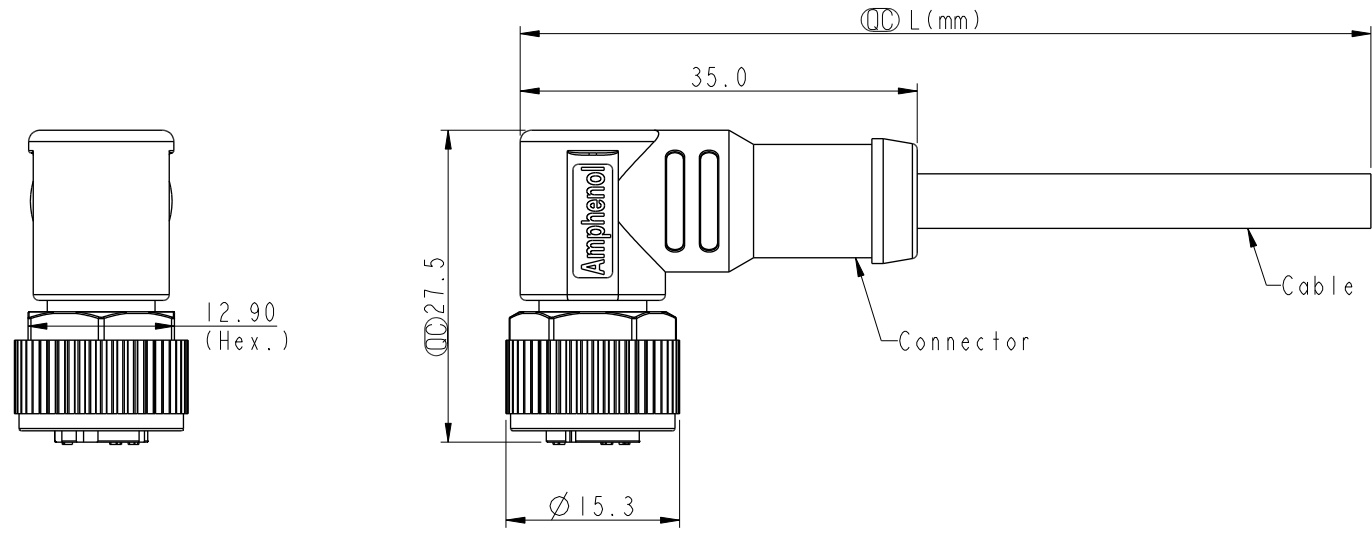

- Note:  $\triangle C$   $\triangle D$
- \* RoHS Compliant
  - \*  $\odot$  Important dimension
  - $\triangle B$ \* Waterproof rate: IPX8, mated 1m/24h  
IPX9K, mated
  - \* Connector
    - Housing: Thermoplastic, Black
    - Pin: Copper alloy, Gold plated
    - O-Ring: Rubber, Green
    - Nut: Thermoplastic, Black
    - Outer mold: Thermoplastic, Black
  - $\triangle B$ \* Cable: UL2517, PVC Jacket, Yellow
  - \* Cable length tolerance: 1M: +50/-0 mm
    - 1M < L ≤ 3M: +100/-0 mm
    - 3M < L ≤ 5M: +150/-0 mm
    - 5M < L ≤ 10M: ±100 mm
    - 10M < L ≤ 20M: ±200 mm
    - 20M < L ≤ 30M: ±300 mm
    - 30M < L ≤ 99M: ±500 mm

UNIT: mm

TOLERANCE



±0.5mm



TITLE N SEN, M12 D -PLASTIC, SCREW CABLE W/O SR, F, F, MOLDING $\triangle D$			
SCALE 3:2	SIZE A4	SHEET 1 OF 2	
REV. D	WC-REV. A.2	$\odot$ : Inspection item	

**Amphenol LTW**  
安費諾亮泰企業股份有限公司

ITEM NO.	DRAWN BY Yulong_wang	DATE 2016-10-14
DWG. NO. $\triangle C$ MSDP-XXBFFM-SR8AXX	CHECKED BY Jinhai	DATE 2016-10-14
CUSTOMER ALTW	APPROVED BY Jerry	DATE 2016-10-14

THIS DOCUMENT IS SUBJECT TO CHANGE WITHOUT NOTICE. IT IS CONFIDENTIAL AND A PROPERTY OF Amphenol LTW. DISCLOSURE TO THIRD PARTY HAS TO BE AUTHORIZED BY Amphenol LTW.

 	5P	5.1	22	MSDP-05BFFM-SR8AXX
	4P	4.8		MSDP-04BFFM-SR8AXX
	3P	4.5		MSDP-03BFFM-SR8AXX
Contacts	Cable OD	AWG	Item No.	

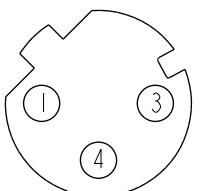
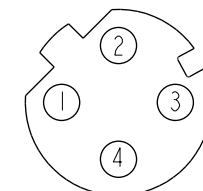
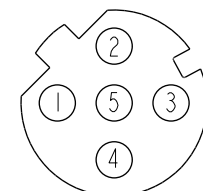

  
  
 MSDP-XXBFFM-SR8AXX  
 XX: No. Of Pin

XX: 01~99Meters  
 01: 01Meter  
 02: 02Meters  
 :  
 99: 99Meters

Pin Out	5	--		5	--		5	Gray	灰
	4	Black	黑	4	Black	黑	4	Black	黑
	3	Blue	藍	3	Blue	藍	3	Blue	藍
	2	--		2	White	白	2	White	白
	1	Brown	棕	1	Brown	棕	1	Brown	棕
	Pin #	Wire		Pin #	Wire		Pin #	Wire	
Conn.	 3P			 4P			 5P		



Pin Assignments Front View

UNIT:mm		TITLE N SEN, M12 D -PLASTIC, SCREW CABLE W/O SR, F, F, MOLDING 	
TOLERANCE	±0.5mm	SCALE 3:2	SIZE A4
		REV. D	WC-REV. A.2
		SHEET 2 OF 2  : Inspection item	

Amphenol LTW

安費諾亮泰企業股份有限公司

ITEM NO	DRAWN BY Yulong_wang	DATE 2016-10-14
DWG NO  MSDP-XXBFFM-SR8AXX	CHECKED BY Jinhai	DATE 2016-10-14
CUSTOMER ALTW	APPROVED BY Jerry	DATE 2016-10-14