

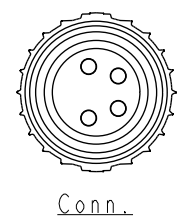

THIS DOCUMENT IS SUBJECT TO CHANGE WITHOUT NOTICE. IT IS CONFIDENTIAL AND A PROPERTY OF Amphenol LTW. DISCLOSURE TO THIRD PARTY HAS TO BE AUTHORIZED BY Amphenol LTW.

REV.	ECN NO.	DATE	SIGN	DESCRIPTION
A		2020/04/29	Vicky	Initial Released
B	C210007	2020/12/29	Ruru	$\triangle B$ X2
C	C210637	2021/05/05	Vicky	$\triangle C$ X1

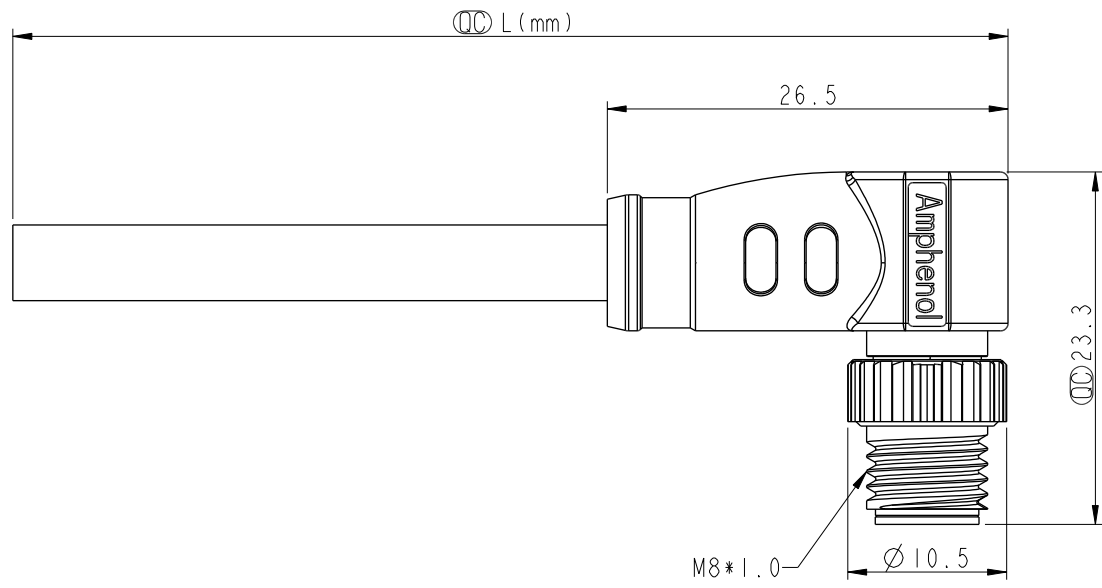

- $\triangle C$  Note:
- \* RoHS Compliant
  - \*  $\text{\textcircled{C}}$  Important dimension
  - \* Waterproof rate: IPX7, mated
  - \* Connector
  - Housing: Thermoplastic, Black
  - Pin: Copper alloy, Gold plated
  - $\triangle B$  Nut: Metal
  - Shield: Metal
  - Outer mold: Thermoplastic, Black
  - \* Cable: UL2517, PVC Jacket, Black
  - \* Cable length tolerance: 1M: +50/-0 mm
  - 1M < L  $\leq$  3M: +100/-0 mm
  - 3M < L  $\leq$  5M: +150/-0 mm
  - 5M < L  $\leq$  10M:  $\pm$ 100 mm
  - 10M < L  $\leq$  20M:  $\pm$ 200 mm
  - 20M < L  $\leq$  30M:  $\pm$ 300 mm
  - 30M < L  $\leq$  99M:  $\pm$ 500 mm

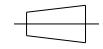
UNIT: mm    
 TOLERANCE  $\pm 0.5$ mm

TITLE N SEN, M8-SHLD, SCREW CABLE W/O SR, M, M, MOLDING		
SCALE 2:1	SIZE A4	SHEET 1 OF 2
REV. C	WC-REV. A.5	$\text{\textcircled{C}}$ : Inspection item

**Amphenol LTW**  
 安費諾亮泰企業股份有限公司

ITEM NO.	DRAWN BY Vicky	DATE 2020-04-29
DWG NO. M8S-XXBMMM-SR7DXX	CHECKED BY Rita	DATE 2020-04-29
CUSTOMER ALTW	APPROVED BY Max	DATE 2020-04-29

THIS DOCUMENT IS SUBJECT TO CHANGE WITHOUT NOTICE. IT IS CONFIDENTIAL AND A PROPERTY OF Amphenol LTW. DISCLOSURE TO THIRD PARTY HAS TO BE AUTHORIZED BY Amphenol LTW.

4P	5.0	24	M8S-04BMMM-SR7DXX
3P	4.6		M8S-03BMMM-SR7DXX
Contacts	Cable OD	AWG	Item No.



M8S-XXBMMM-SR7DXX

 XX: No. Of Pin

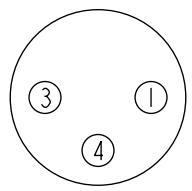
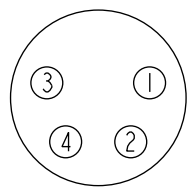
XX: 01~99Meters  
 01: 01 Meter  
 02: 02 Meters  
 :  
 99: 99 Meters

Pin Out	Shield	Braid	黑 藍 白 棕	Shield	Braid	黑 藍 白 棕
	4	Black		4	Black	
	3	Blue		3	Blue	
	1	Brown		2	White	
	Pin #	Wire		1	Brown	
Conn.						
	3P			4P		

Pin Assignments Front View

UNIT:mm  

TOLERANCE  
±0.5mm

TITLE N SEN, M8-SHLD, SCREW CABLE W/O SR, M, M, MOLDING			
SCALE 1:1	SIZE A4	SHEET 2 OF 2	
REV. C	WC-REV. .0	QC: Inspection item	

**Amphenol LTW**  
安費諾亮泰企業股份有限公司

ITEM NO	DRAWN BY Vicky	DATE 2020-04-29
DWG NO M8S-XXBMMM-SR7DXX	CHECKED BY Rita	DATE 2020-04-29
CUSTOMER ALTW	APPROVED BY Max	DATE 2020-04-29