

THIS DOCUMENT IS SUBJECT TO CHANGE WITHOUT NOTICE. IT IS CONFIDENTIAL AND A PROPERTY OF AMPHENOL LTW. DISCLOSURE TO THIRD PARTY HAS TO BE AUTHORIZED BY AMPHENOL LTW.

REV.	ECN NO.	DATE	SIGN	DESCRIPTION
B	LEN1741306	2017/04/20	Ruru	Change Logo

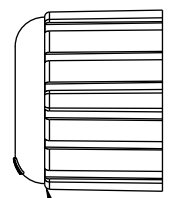

8 Sealing Nut

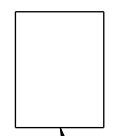

7 Seal B2

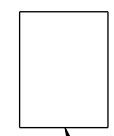

6 Seal B1

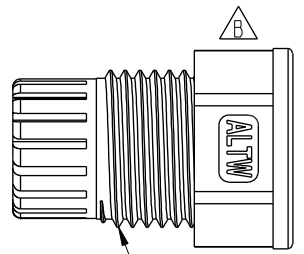

5 Clamp Ring



4 Gasket

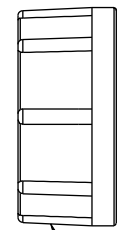

3 Lock Nut

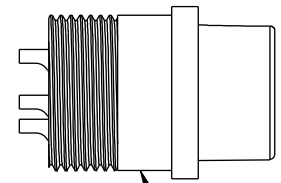

1 Housing



2 O-Ring

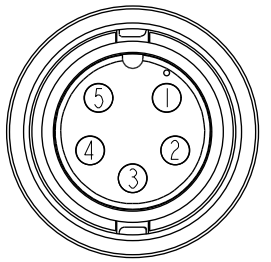
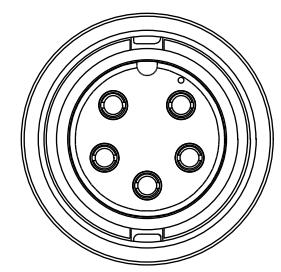
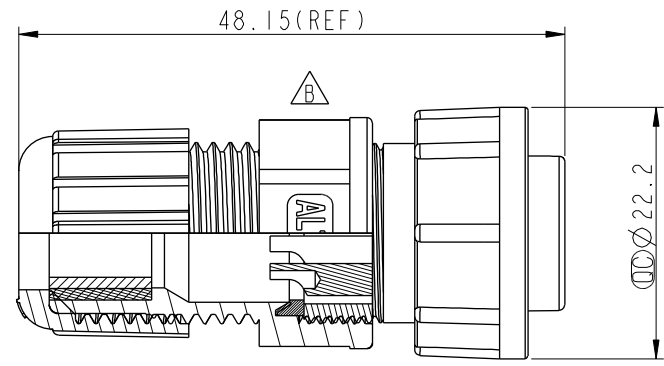

Pin Assignments  
Front View



- Note:
- \*  $\varnothing$  Important Dimension To Check.
  - \* Waterproof Rate: IP67
  - \* Housing: Nylon+GF, Black.
  - \* Female Pin: Copper Alloy, Gold Plated.
  - \* O-Ring: EPDM, Black.
  - \* Lock Nut: Nylon+GF, Black.
  - \* Gasket: EPDM, Black.
  - \* Clamp Ring: Nylon, Black.
  - \* Sealing Nut: Nylon, Black.
  - \* Seals B1 for Cable OD:  $\varnothing 7.6\text{mm} \sim \varnothing 9.6\text{MM}$
  - \* Seals B2 for Cable OD:  $\varnothing 4.0\text{MM} \sim \varnothing 7.6\text{MM}$
  - \* One Set Unassembled in One PE Bag.

A	UNIT:mm			TITLE	Middle, Assy Lock 5Pin F Conn F Pin		Amphenol LTW	ITEM NO	CB-05BFFA-LL7001	DRAWN BY	Ruru	DATE	2017-04-20	
	TOLERANCE	.X $\pm 0.25$	.XX $\pm 0.1$	SCALE	1:1	SIZE	A4	DWG NO	CB-05BFFA-LL7001	CHECKED BY	Rita	DATE	2017-04-20	
	.XXX $\pm 0.05$	ANGLES $\pm 1^\circ$	REV.	B	WC-REV.	A.2	SHEET	1	OF	1	APPROVED BY	Max	DATE	2017-04-20
					REV.	B	WC-REV.	A.2	CUSTOMER	ALTW	APPROVED BY	Max	DATE	2017-04-20

**Amphenol LTW**  
安費諾亮泰企業股份有限公司