

THIS DOCUMENT IS SUBJECT TO CHANGE WITHOUT NOTICE. IT IS CONFIDENTIAL AND A PROPERTY OF AMPHENOL LTW. DISCLOSURE TO THIRD PARTY HAS TO BE AUTHORIZED BY AMPHENOL LTW.

REV.	ECN NO.	DATE	SIGN	DESCRIPTION
D	C191385	2019/08/02	Siou	Revise Rated Voltage.
E	E191814	2019/10/23	Ruru	△E x 3
F	C210786	2021/06/06	Angel Chou	△E x 5

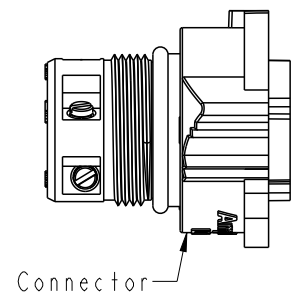
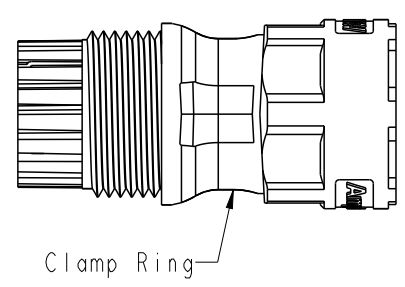
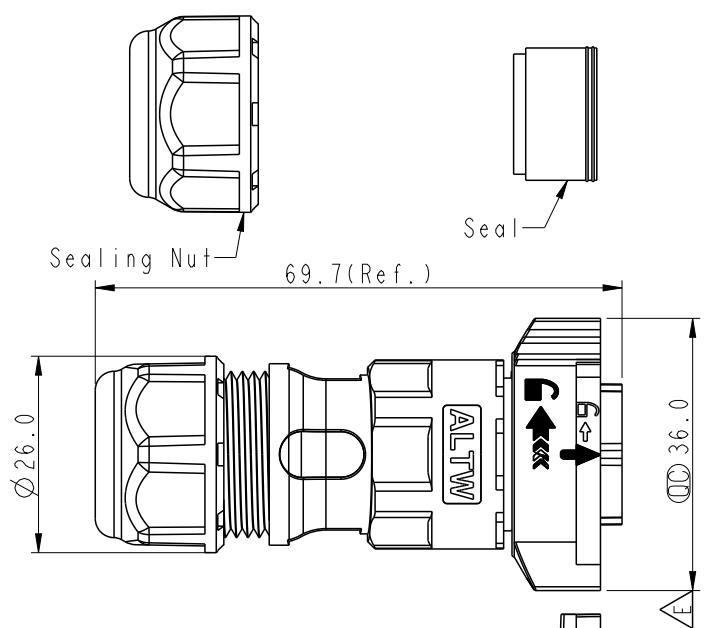

- DC-XXBFFB-QL8XPP
- △ 02-2 Pin
  - △ 03-3 Pin
  - △ 04-4 Pin
  - △ 05-5 Pin

- S: With Red Color Seal 1, Cable OD 8.0~10.0mm.
- M: With Yellow Color Seal 2, Cable OD 10.0~12.0mm.
- L: With Blue Color Seal 3, Cable OD 12.0~14.0mm.
- A: With Seal 1 & Seal 2 & Seal 3.

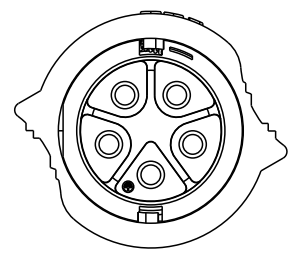
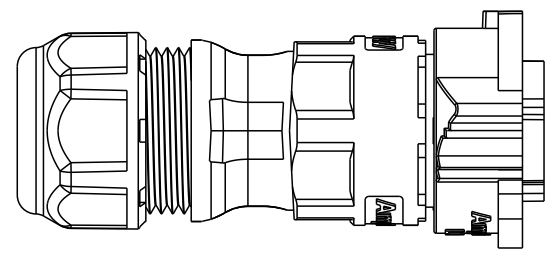

△E △F Note:

- \* RoHS Compliant
- \* ⌀ Important Dimension
- \* Waterproof Rate: IPX8, Mated 1m/24h
- \* Connector
- Housing: Thermoplastic, Black
- Pin: Copper Alloy, Gold Plated
- Clamp Ring: Thermoplastic, Black
- Sealing Nut: Thermoplastic, Black
- Seals: Rubber

Pin Assignments Front View

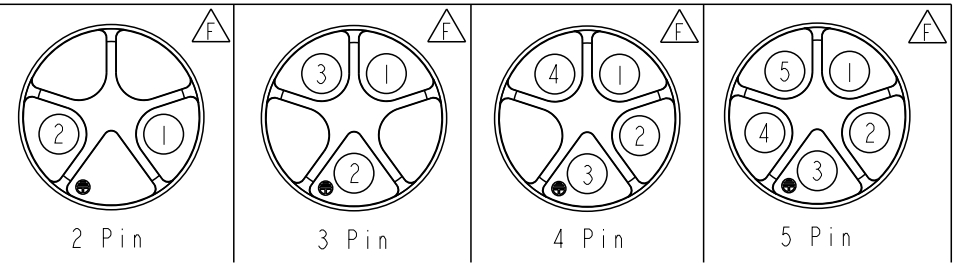

UNIT:mm		TITLE	XLOK, D-20A, 02P, CABLE W/O SR F, F, FI SCREW IN, XLOK	
TOLERANCE	±0.5 mm	SCALE	8:5	SIZE A4
		REV.	F	WC-REV. A.3
				⌀: Inspection item

**Amphenol LTW**  
安費諾亮泰企業股份有限公司

ITEM NO	DC-XXBFFB-QL8XPP	DRAWN BY	Siou	DATE	2019-08-02
DWG NO	DC-XXBFFB-QL8XPP	CHECKED BY	Eagle	DATE	2019-08-02
CUSTOMER	ALTM	APPROVED BY	Neo	DATE	2019-08-02

THIS DOCUMENT IS SUBJECT TO CHANGE WITHOUT NOTICE. IT IS CONFIDENTIAL AND A PROPERTY OF Amphenol LTW. DISCLOSURE TO THIRD PARTY HAS TO BE AUTHORIZED BY Amphenol LTW.

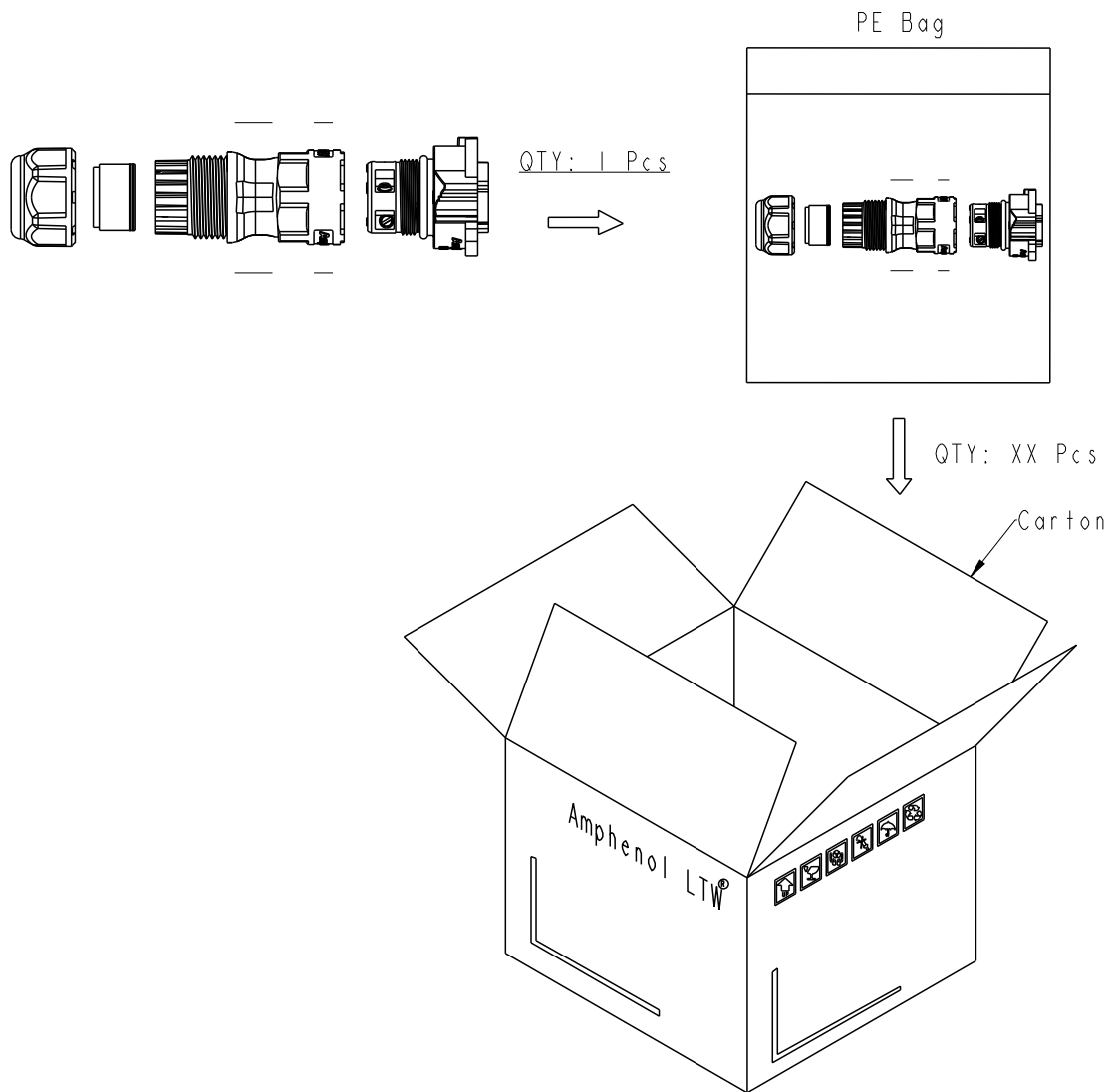

Note:  
 \* One Set Unassembled In One PE Bag.  
 (每一組未組裝，放置於一個PE袋，並封口，如圖示)  
 \* Label is Attached To PE Bag Front.  
 (標籤貼在PE袋正面)

UNIT:mm	
TOLERANCE ±0.5 mm	

TITLE XLOK, D-20A, 02P, CABLE W/O SR F, F, FI SCREW IN, XLOK			
SCALE 8:5	SIZE A4	SHEET 2 OF 2	
REV. F	WC-REV. A.3	☉: Inspection item	

**Amphenol LTW**  
 安費諾亮泰企業股份有限公司

ITEM NO	DRAWN BY Siou	DATE 2019-08-02
DWG NO DC-XXBFFB-QL8XPP	CHECKED BY Eagle	DATE 2019-08-02
CUSTOMER ALTW	APPROVED BY Neo	DATE 2019-08-02