

THIS DOCUMENT IS SUBJECT TO CHANGE WITHOUT NOTICE. IT IS CONFIDENTIAL AND A PROPERTY OF Amphenol LTW. DISCLOSURE TO THIRD PARTY HAS TO BE AUTHORIZED BY Amphenol LTW.

| REV. | ECN NO. | DATE | SIGN | DESCRIPTION |
|------|---------|------------|------|------------------|
| B | E191899 | 2019/11/15 | Ruru | $\triangle B$ X4 |
| | | | | |

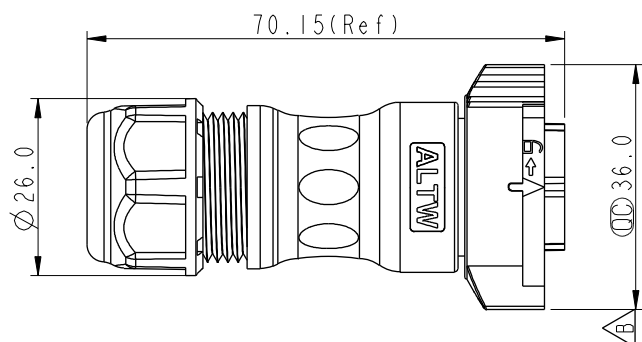
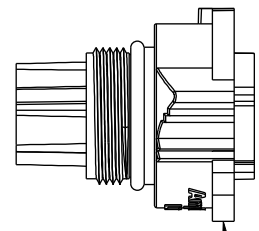
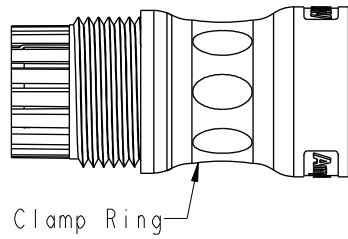
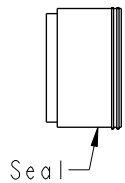
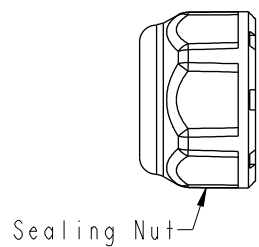

DC-XXBFFA-QL8XPP
 02-2 Pin
 03-3 Pin
 05-5 Pin

S: With Red Color Seal 1, Cable OD 6.0~8.0mm.
 M: With Yellow Color Seal 2, Cable OD 8.0~10.0mm.
 L: With Blue Color Seal 3, Cable OD 10.0~12.0mm.
 A: With Seal 1 & Seal 2 & Seal 3.

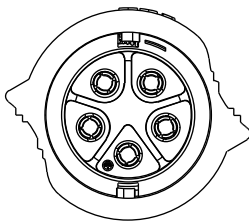
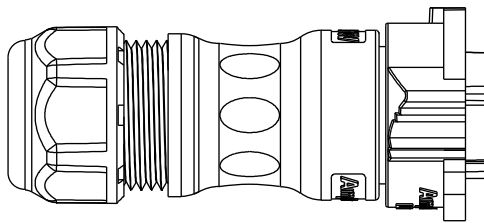

- $\triangle B$ Note:
- * \varnothing Important Dimension
 - * Waterproof Rate: IP68, Mated
 IP68 : 1M Depth Of Water In 24hours
 - * Housing: Thermoplastic, Black
 - * Pin: Copper Alloy, Gold Plated
 - * Clamp Ring: Thermoplastic, Black
 - * Sealing Nut: Thermoplastic, Black
 - * Seals: Rubber

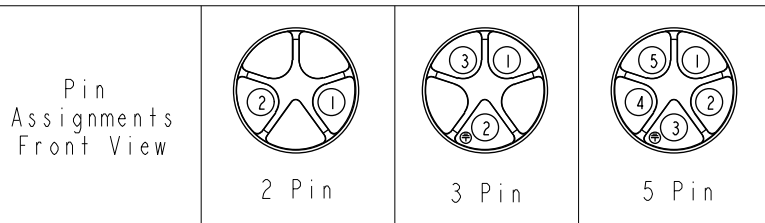

| | | | | | | | | | | |
|--------------------------------------|--|--|---------------|---------------------------------|---------|--|--|--------------------|--|--------------------|
| UNIT:mm TOLERANCE ± 0.5 mm | | TITLE XLOK, D-20A, CABLE W/O SR F, F, FI CRIMP, XLOK $\triangle B$ | | ITEM NO | | DRAWN BY Ruru | | DATE 2019-11-15 | | |
| | | SCALE 1:1 | SIZE A4 | SHEET 1 | OF 1 | DWG NO DC-XXBFFA-QL8XPP $\triangle B$ | | CHECKED BY Rita | | DATE 2019-11-15 |
| | | REV. B | WC-REV. .0 | \varnothing : Inspection item | | CUSTOMER ALTW | | APPROVED BY Max | | DATE 2019-11-15 |

Amphenol LTW
 安費諾亮泰企業股份有限公司