

THIS DOCUMENT IS SUBJECT TO CHANGE WITHOUT NOTICE. IT IS CONFIDENTIAL AND A PROPERTY OF Amphenol LTW. DISCLOSURE TO THIRD PARTY HAS TO BE AUTHORIZED BY Amphenol LTW.

REV.	ECN NO.	DATE	SIGN	DESCRIPTION
A		2016/11/23	Victor Hung	Change Rev.01 To Rev.A
B	CI92027	2019/11/21	Vicky	$\triangle B$ X4

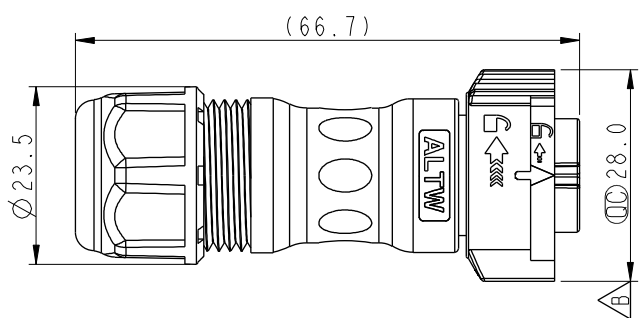
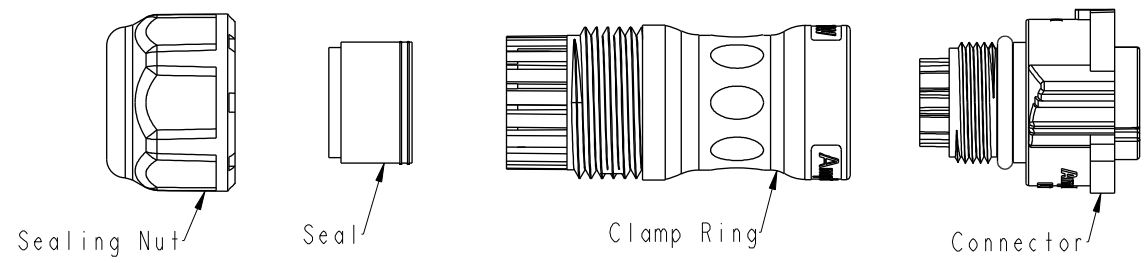

CD-XXBFFA-QL8XP0

08- 8Pin
 09- 9Pin
 10-10Pin
 12-12Pin

S: With Red Color Seal 1, Cable OD 6.0~8.0mm.
 M: With Yellow Color Seal 2, Cable OD 8.0~10.0mm.
 L: With Blue Color Seal 3, Cable OD 10.0~12.0mm.
 A: With Seal 1 & Seal 2 & Seal 3.

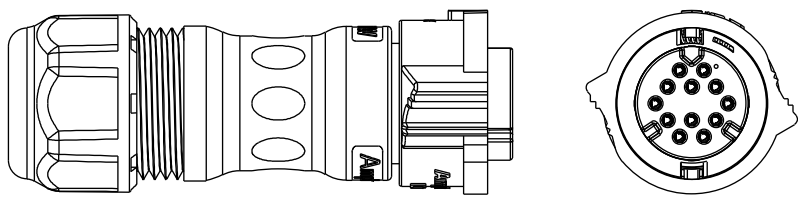

- $\triangle B$ Note:
- * \varnothing Important Dimension
 - * Waterproof Rate: IP68, Mated IP68: 1M Depth Of Water In 24hours
 - * Housing: Thermoplastic, Black
 - * Pin: Copper Alloy, Gold Plated
 - * Clamp Ring: Thermoplastic, Black
 - * Sealing Nut: Thermoplastic, Black
 - * Seals: Rubber

Pin Assignments Front View

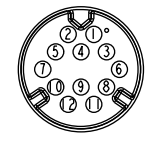
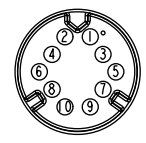
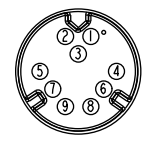
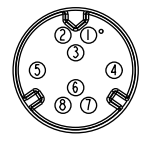

8 Pin

9 Pin

10 Pin

12 Pin

UNIT:mm

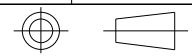

TOLERANCE
±0.5mm

TITLE
XLOK, C-5A, CABLE W/O SR
F, F, FI CRIMP, XLOK

SCALE 1:1 SIZE A4 SHEET 1 OF 1
 REV. B WC-REV. A.5 \varnothing Inspection item

Amphenol LTW
 安費諾亮泰企業股份有限公司

ITEM NO
 DWG NO CD-XXBFFA-QL8XP0
 CUSTOMER ALTW

DRAWN BY Victor Hung
 CHECKED BY Wes Fan
 APPROVED BY Kevin Hu

DATE 2016-11-23
 DATE 2016-11-23
 DATE 2016-11-23