

THIS DOCUMENT IS SUBJECT TO CHANGE WITHOUT NOTICE. IT IS CONFIDENTIAL AND A PROPERTY OF Amphenol LTW. DISCLOSURE TO THIRD PARTY HAS TO BE AUTHORIZED BY Amphenol LTW.

REV.	ECN NO.	DATE	SIGN	DESCRIPTION
A	Initial Release	2018/03/14	Mafei	Change Rev.01 To Rev.A
B	E191814	2019/10/23	Ruru	$\triangle B$ X3

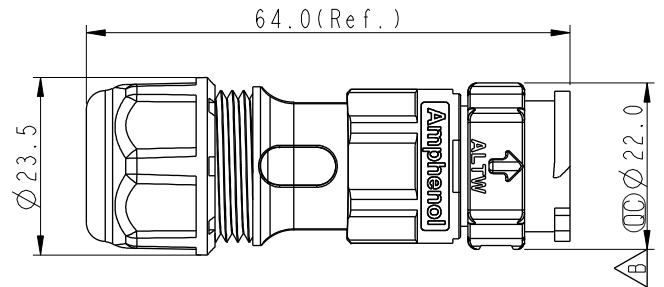
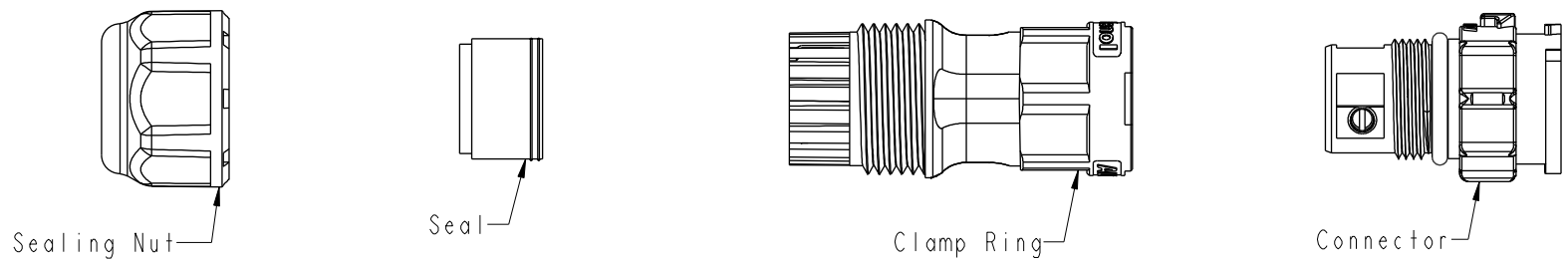

CC-XXBMMB-QLXPP

02-2 Pin
03-3 Pin

S: With Red Color Seal 1, Cable OD 6.0~8.0mm.
M: With Yellow Color Seal 2, Cable OD 8.0~10.0mm.
L: With Blue Color Seal 3, Cable OD 10.0~12.0mm.
A: With Seal 1 & Seal 2 & Seal 3.

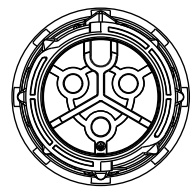
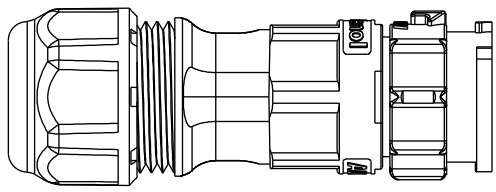

Pin Assignments Front View



2 Pin

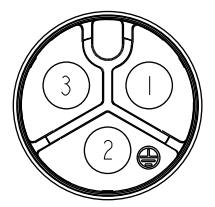

3 Pin

- $\triangle B$ Note:
- * \varnothing Important Dimension
 - * Waterproof Rate: IP68, Mated
 - IP68 : IM Depth Of Water In 24hours
 - * Housing: Thermoplastic, Black
 - * Pin: Copper Alloy, Gold Plated
 - * Clamp Ring: Thermoplastic, Black
 - * Sealing Nut: Thermoplastic, Black
 - * Seals: Rubber

UNIT:mm		TITLE
TOLERANCE	± 0.5 mm	XLOK, C-20A, 02P, CABLE W/O SR M, M, FI SCREW IN, XLOK $\triangle B$
SCALE	8:5	SIZE A4
REV.	B	SHEET 1 OF 2
WC-REV.	A.3	\varnothing : Inspection item

Amphenol LTW
安費諾亮泰企業股份有限公司

ITEM NO	DRAWN BY	DATE
DWG NO	CHECKED BY	DATE
CUSTOMER	APPROVED BY	DATE
ALTW	Mafei	2018-03-14
	Jerry	2018-03-14
	Max	2018-03-14

THIS DOCUMENT IS SUBJECT TO CHANGE WITHOUT NOTICE. IT IS CONFIDENTIAL AND A PROPERTY OF Amphenol LTW. DISCLOSURE TO THIRD PARTY HAS TO BE AUTHORIZED BY Amphenol LTW.

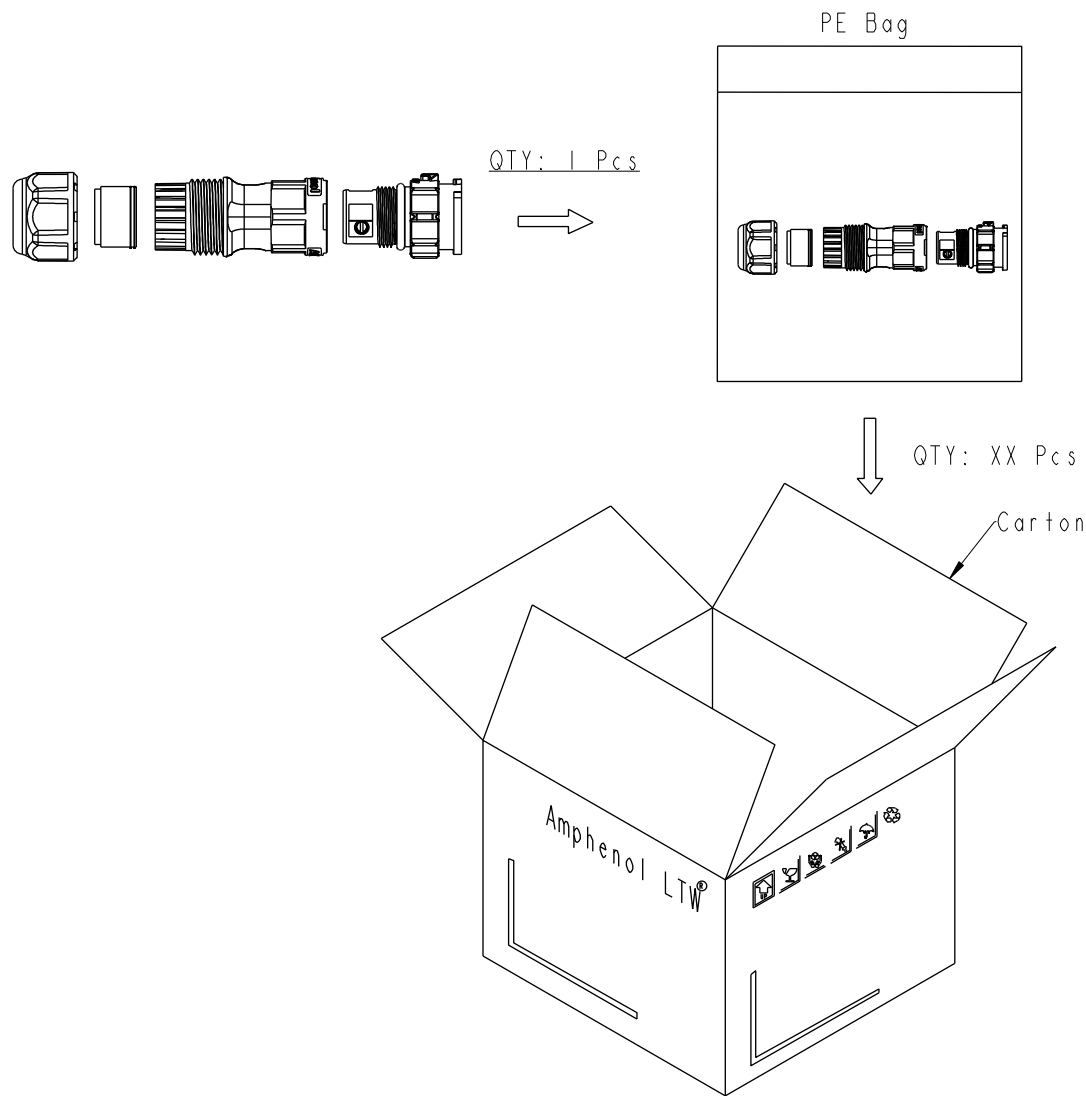

Note:
 * One Set Unassembled In One PE Bag.
 (每一組未組裝，放置於一個PE袋，並封口，如圖示)
 * Label is Attached To PE Bag Front.
 (標籤貼在PE袋正面)

UNIT:mm 
 TOLERANCE
 ±0.5 mm

TITLE XLOK, C-20A, 02P, CABLE W/O SR M, M, FI SCREW IN, XLOK 			
SCALE 8:5	SIZE A4	SHEET 2 OF 2	
REV. B	WC-REV. A.3	QC: Inspection item	

Amphenol LTW
 安費諾亮泰企業股份有限公司

ITEM NO	DRAWN BY Mafei	DATE 2018-03-14
DWG NO CC-XXBMMB-QL8XPP	CHECKED BY Jerry	DATE 2018-03-14
CUSTOMER ALTW	APPROVED BY Max	DATE 2018-03-14