

THIS DOCUMENT IS SUBJECT TO CHANGE WITHOUT NOTICE. IT IS CONFIDENTIAL AND A PROPERTY OF Amphenol LTW. DISCLOSURE TO THIRD PARTY HAS TO BE AUTHORIZED BY Amphenol LTW.

REV.	ECN NO.	DATE	SIGN	DESCRIPTION
A		2020/01/13	Ruru	Initial Released

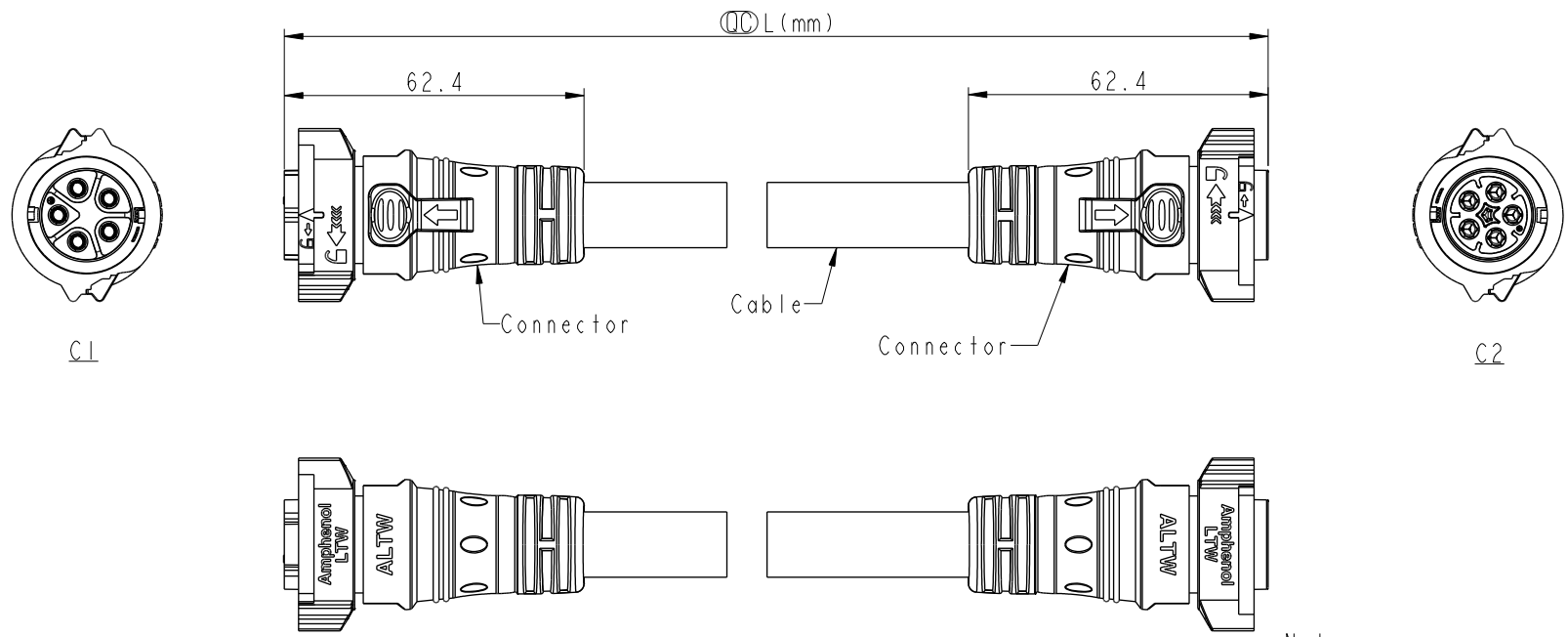

- Note:
- * \varnothing Important Dimension.
 - * Waterproof Rate: IP68, Mated.
IP68: 1M depth of water in 24 hours.
 - * Connector: Thermoplastic, Black.
 - * Pin: Copper Alloy, Gold Plated.
 - * Cable: SJTW, PVC Jacket, Black.
 - * Cable Length Tolerance: 0.5M: +60/-0mm
01M: +60/-0mm
02~03M: +120/-0mm
04~05M: +160/-0mm
06~10M: ±100mm
11~20M: ±200mm
21~30M: ±300mm
31~99M: ±500mm

UNIT: mm	
TOLERANCE	±0.5 mm

TITLE ACC, XLOK, D-20A, DB-ENDED FF		
SCALE 1:2	SIZE A4	SHEET 1 OF 2
REV. A	WC-REV.	\varnothing : Inspection item

Amphenol LTW
安費諾亮泰企業股份有限公司

ITEM NO.	DRAWN BY Ruru	DATE 2020-01-13
DWG NO. AB-DCXXFL-DCBL-QEXXX	CHECKED BY Rita	DATE 2020-01-13
CUSTOMER ALTW	APPROVED BY Max	DATE 2020-01-13

THIS DOCUMENT IS SUBJECT TO CHANGE WITHOUT NOTICE. IT IS CONFIDENTIAL AND A PROPERTY OF AMPHENOL LTW. DISCLOSURE TO THIRD PARTY HAS TO BE AUTHORIZED BY AMPHENOL LTW.

5P		PVC	13.6	12	AB-DC05FL-DCBL-QEXXX
3P			11.7		AB-DC03FL-DCBL-QEXXX
2P			10.7		AB-DC02FL-DCBL-QEXXX
Contacts	Cable Jacket	Cable OD	AWG	Item No.	

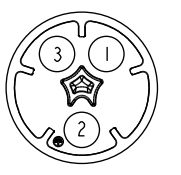
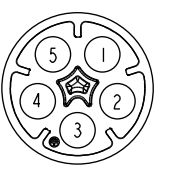
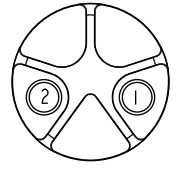
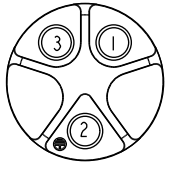
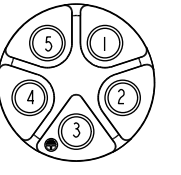
Pin Out	2 White 白 1 Black 黑	3 Green 綠 2 White 白 1 Black 黑	5 Brown 棕 4 Red 紅 3 Green 綠 2 White 白 1 Black 黑
	Pin # Wire	Pin # Wire	Pin # Wire
C2			
	2P	3P	5P
C1			
	2P	3P	5P
Pin Assignments Front View			

AB-DCXXFL-DCBL-QEXXX

02: 2Pin
03: 3Pin
05: 5Pin

XXX: 0.5~99Meters
A05: 0.5 Meter
001: 01 Meter
002: 02 Meters
:
099: 99 Meters

UNIT:mm 

TOLERANCE
± 0.5 mm

TITLE ACC, XLOK, D-20A, DB-ENDED
FF

SCALE 1:2 SIZE A4 SHEET 2 OF 2

REV. A WC-REV. : Inspection item

Amphenol LTW
安費諾亮泰企業股份有限公司

ITEM NO	DRAWN BY Ruru	DATE 2020-01-13
DWG NO AB-DCXXFL-DCBL-QEXXX	CHECKED BY Rita	DATE 2020-01-13
CUSTOMER ALTW	APPROVED BY Max	DATE 2020-01-13