

THIS DOCUMENT IS SUBJECT TO CHANGE WITHOUT NOTICE. IT IS CONFIDENTIAL AND A PROPERTY OF Amphenol LTW. DISCLOSURE TO THIRD PARTY HAS TO BE AUTHORIZED BY Amphenol LTW.

REV.	ECN NO.	DATE	SIGN	DESCRIPTION
A		2020/01/09	Ruru	Initial Released

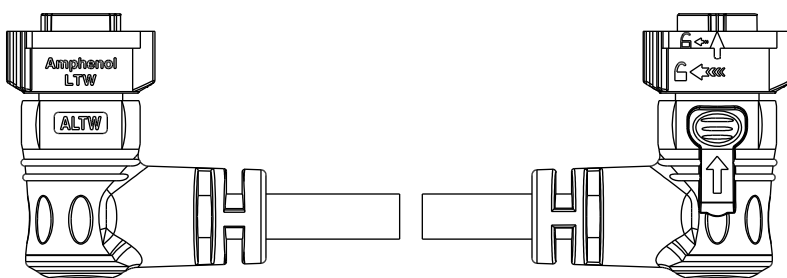
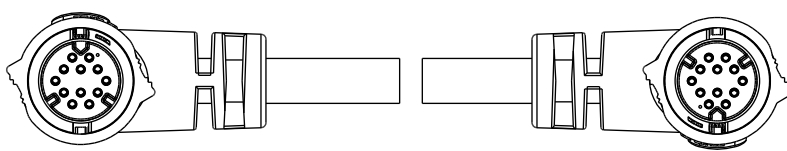
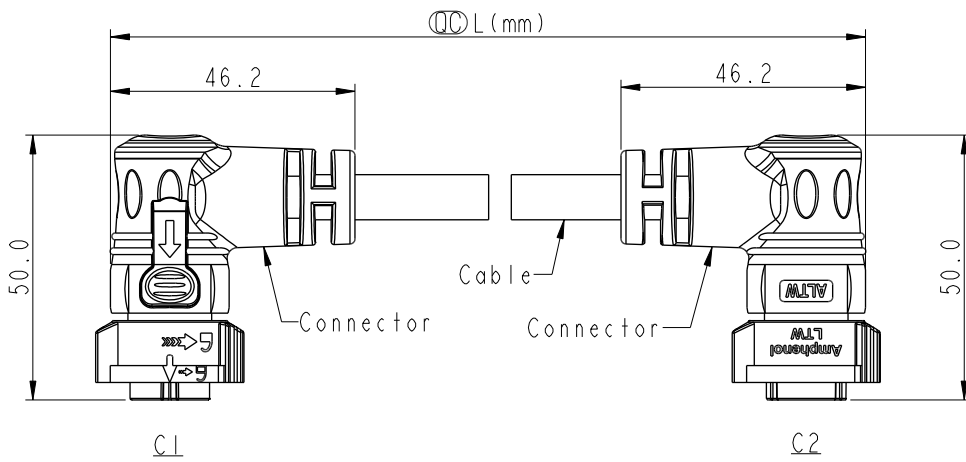

- Note:
- * \varnothing Important Dimension.
 - * Waterproof Rate: IP68, Mated.
IP68: 1M depth of water in 24 hours.
 - * Connector: Thermoplastic, Black.
 - * Pin: Copper Alloy, Gold Plated.
 - * Cable: UL21388, PVC Jacket, Black.
 - * Cable Length Tolerance: 0.5M: +60/-0mm
01M: +60/-0mm
02~03M: +120/-0mm
04~05M: +160/-0mm
06~10M: ±100mm
11~20M: ±200mm
21~30M: ±300mm
31~99M: ±500mm

UNIT:mm		
TOLERANCE	±0.5 mm	

TITLE ACC, XLOK, C-5A, DB-ENDED FF		
SCALE 1:2	SIZE A4	SHEET 1 OF 2
REV. A	WC-REV.	\varnothing : Inspection item

Amphenol LTW
安費諾亮泰企業股份有限公司

ITEM NO.	DRAWN BY Ruru	DATE 2020-01-09
DWG NO. AB-CDXXFR-CDFR-QDXXX	CHECKED BY Rita	DATE 2020-01-09
CUSTOMER ALTW	APPROVED BY Max	DATE 2020-01-09

THIS DOCUMENT IS SUBJECT TO CHANGE WITHOUT NOTICE. IT IS CONFIDENTIAL AND A PROPERTY OF Amphenol LTW. DISCLOSURE TO THIRD PARTY HAS TO BE AUTHORIZED BY Amphenol LTW.

1 2 3 4 5 6 7 8

AB- CC XX FR - CC FR - QD XXX

07: 7Pin
08: 8Pin
09: 9Pin
10: 10Pin
12: 12Pin

XXX: 0.5~99Meters
A05: 0.5 Meter
001: 01 Meter
002: 02 Meters
:
099: 99 Meters

12P	PVC	8.5	20	AB-CD12FR-CDFR-QDXXX
10P		8.5		AB-CD10FR-CDFR-QDXXX
9P		7.6		AB-CD09FR-CDFR-QDXXX
8P		7.2		AB-CD08FR-CDFR-QDXXX
7P		6.8		AB-CD07FR-CDFR-QDXXX
Contacts	Cable Jacket	Cable OD	AWG	Item No.

Pin Out	Wire	Pin #	Wire	Pin #	Wire	Pin #	Wire	Pin #	Wire	Pin #	Wire
7	Orange 橙	8	Green 綠	9	Brown 棕	10	White 白	12	Light Green 淡綠		
6	Blue 藍	7	Orange 橙	8	Green 綠	9	Gray 灰	11	Pink 粉紅		
8	Green 綠	6	Blue 藍	7	Orange 橙	8	Purple 紫	10	White 白		
4	Yellow 黃	5	Purple 紫	6	Blue 藍	7	Blue 藍	9	Gray 灰		
3	Black 黑	4	Yellow 黃	5	Purple 紫	6	Green 綠	8	Purple 紫		
2	Red 紅	3	Black 黑	4	Yellow 黃	5	Yellow 黃	7	Blue 藍		
1	Brown 棕	2	Red 紅	3	Black 黑	4	Orange 橙	6	Green 綠		
		1	Brown 棕	2	Red 紅	3	Red 紅	5	Yellow 黃		
				1	Gray 灰	2	Brown 棕	4	Orange 橙		
						1	Black 黑	3	Red 紅		
								2	Brown 棕		
								1	Black 黑		

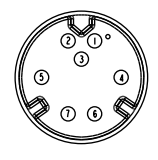
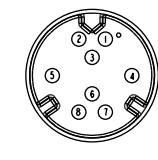
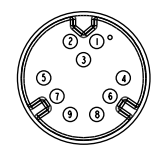
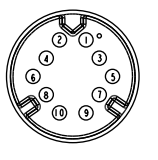
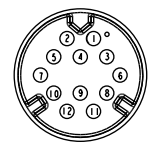
CI	Pin Assignments Front View
	 <p>7P</p>
	 <p>8P</p>
	 <p>9P</p>
	 <p>10P</p>
	 <p>12P</p>

UNIT:mm TOLERANCE ± 0.5 mm	TITLE ACC, XLOK, C-5A, DB-ENDED FF		<h1>Amphenol LTW</h1> <p>安費諾亮泰企業股份有限公司</p>	ITEM NO	DRAWN BY Ruru	DATE 2020-01-09	
	SCALE 1:2	SIZE A4		SHEET 2 OF 2	DWG NO AB-CDXXFR-CDFR-QDXXX	CHECKED BY Rita	DATE 2020-01-09
	REV. A	WC-REV.		QC: Inspection item	CUSTOMER ALTW	APPROVED BY Max	DATE 2020-01-09