

THIS DOCUMENT IS SUBJECT TO CHANGE WITHOUT NOTICE. IT IS CONFIDENTIAL AND A PROPERTY OF AMPHENOL LTW. DISCLOSURE TO THIRD PARTY HAS TO BE AUTHORIZED BY AMPHENOL LTW.

REV.	ECN NO.	DATE	SIGN	DESCRIPTION
B	LE31580197~99	2015/08/12	Lu Di	Change To Common Drawing
C	LEN1680344 LEN1680350-51	2016/08/08	Mafei	Updated The Pin Out Color.

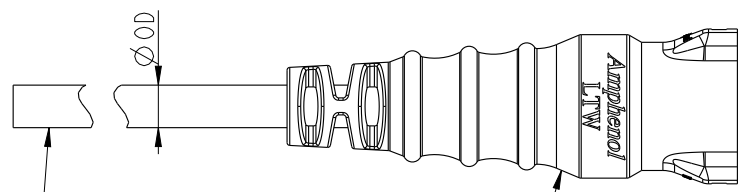
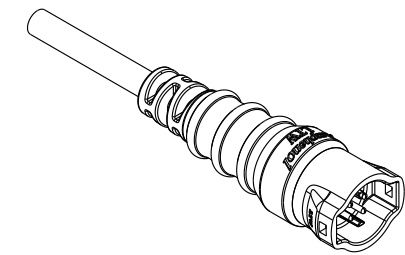
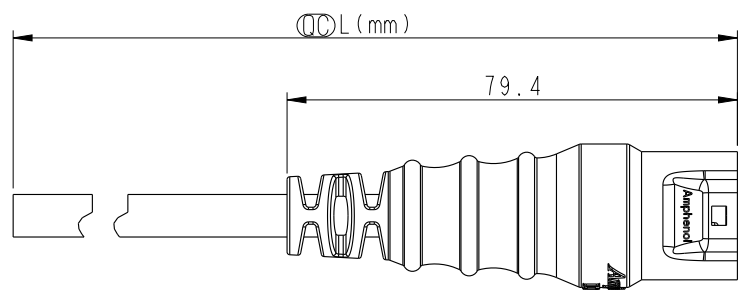

Cable ②

CB-XXAFMM-RL7000 ①
Color: Black

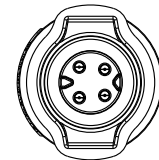

Conn

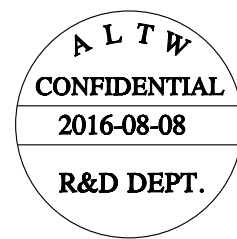

- Note:
- * \varnothing Important Dimension To Check.
 - * Waterproof Rate: IP67
 - * Housing: M-PPE, Black.
 - * Male Pin: Copper Alloy, Gold Plated.
 - * Cable: UL2464 16#, PVC Jacket, UV Resistant, Black.
 - * Cable Length Tolerance: 01M: ± 40 mm
02M~05M: ± 60 mm
06M~10M: ± 100 mm
11M~30M: ± 200 mm
31M~99M: ± 500 mm
 - * Prohibiting the use of place in oils

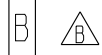

CB-02AFMM-RL7AXX	$\varnothing 7.8$
CB-03AFMM-RL7AXX	$\varnothing 7.5$
CB-04AFMM-RL7AXX	$\varnothing 7.5$
Part No.	Cable OD

UNIT: mm	TOLERANCE	TITLE	SCALE	SIZE	SHEET	OF
± 0.5		MIDDLE CABLE RBL F CONN M PIN	3:4	A4	1	2
		REV. C	WC-REV. A.3	\varnothing : Inspection item		

Amphenol LTW
安費諾亮泰企業股份有限公司

ITEM NO.	DRAWN BY	DATE
	Mafei	2016/08/08
DWG NO.	CHECKED BY	DATE
CB-XXAFMM-RL7AXX	Joyy	2016/08/08
CUSTOMER	APPROVED BY	DATE
ALTW	Jerry	2016/08/08



F

E

D

C

B

A

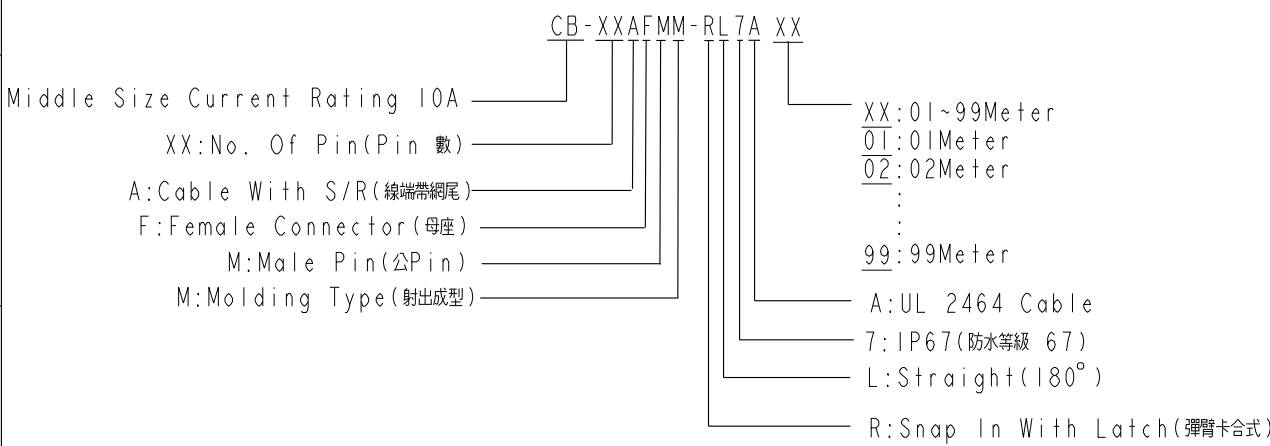

Pin Out	4 -- 3 Red 紅 2 -- 1 Black 黑	4 Green 綠 3 White 白 2 -- 1 Black 黑	4 Orange 橙 3 Red 紅 2 Brown 棕 1 Black 黑
Pin Assignments Front View	 2Pin	 3Pin	 4Pin

UNIT:mm		TITLE MIDDLE CABLE RBL F CONN M PIN	Amphenol LTW 安費諾亮泰企業股份有限公司	ITEM NO	DRAWN BY Mafei	DATE 2016/08/08
TOLERANCE ±0.5		SCALE 3:4	SIZE A4	DWG NO CB-XXAFMM-RL7AXX	CHECKED BY Joyy	DATE 2016/08/08
REV. C	WC-REV. A.3	SHEET 2 OF 2	QC: Inspection item	CUSTOMER ALTW	APPROVED BY Jerry	DATE 2016/08/08